

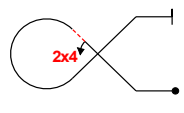

Italia 7 dicembre 2014		Form A
Pilot ID	CIVA	
		Flight #

No	Symbol	Cat. No.	K	Total K	Marks	Remarks	Pos	Item	K	Grade
1		7.3.2.1 9.4.2.2	14 7	21				Pos.		
2		1.1.6.3 9.11.1.6	10 3	13				Fig K		Total K
3		5.2.1.1 9.1.5.1	17 2	19				165		165
Penalties										
4		7.2.1.1	6	6				Too Low		
5		2.1.1.2	4	4				Disqual Fig		
6		1.1.1.4 9.1.3.2	2 4	6				Too High		
7		8.5.2.1 9.1.2.2	10 6	16				Outs		
8		7.8.4.1 9.1.4.2 9.1.4.2	19 4 4	27				Interruptions		
9		8.5.6.1 9.4.4.2	10 5	15				Insertions		
10		8.4.1.1	13	13				Missed Slot		
11		7.2.2.1 9.4.3.2	6 5	11				Trg Violation		
12		2.2.1.1	4	4				Faulty Wing Rocks		
13		1.1.1.1 9.1.3.4	2 8	10				Final Freestyle		
								Duration	Min	Sec
Judges Details										
Signature										
Name										
Number										

Sportmen 2015 Pilot
 A/C

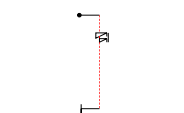
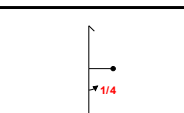
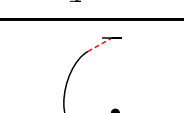
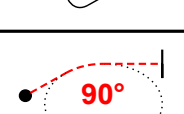
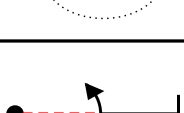
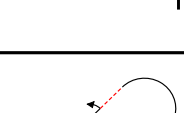
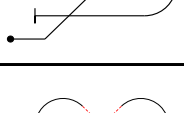
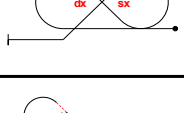
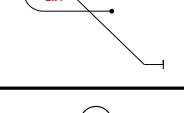
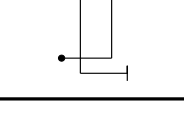
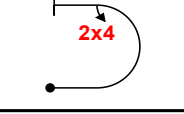
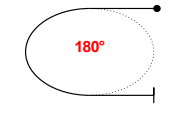

Italia 7 dicembre 2014		Form B
Pilot ID	CIVA	
	Flight #	

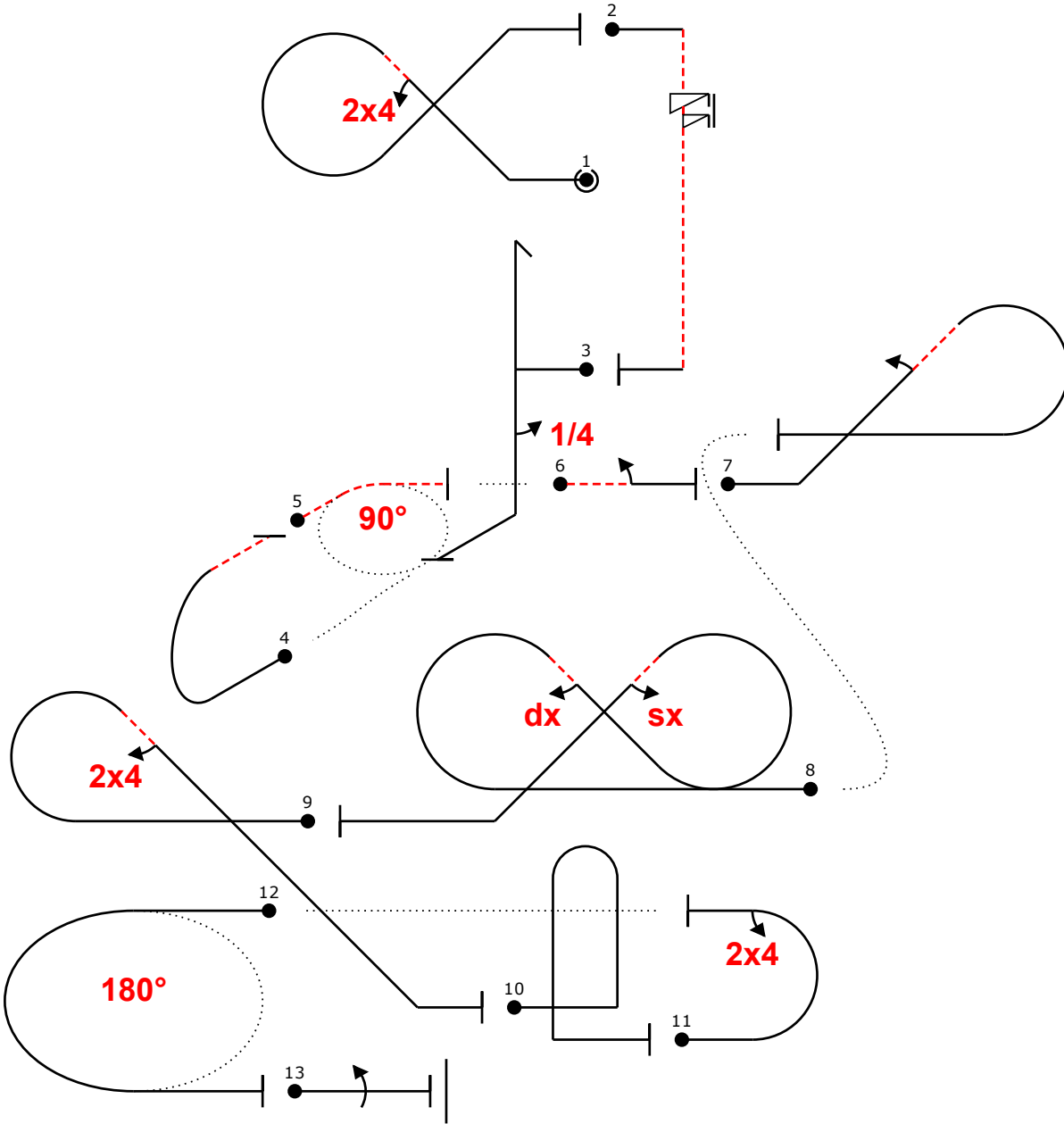
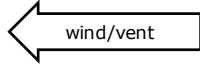

Power			
Fig 1	7.3.2.1 9.4.2.2	14 7	21
Fig 2	1.1.6.3 9.11.1.6	10 3	13
Fig 3	5.2.1.1 9.1.5.1	17 2	19
Fig 4	7.2.1.1	6	6
Fig 5	2.1.1.2	4	4
Fig 6	1.1.1.4 9.1.3.2	2 4	6
Fig 7	8.5.2.1 9.1.2.2	10 6	16
Fig 8	7.8.4.1 9.1.4.2 9.1.4.2	19 4 4	27
Fig 9	8.5.6.1 9.4.4.2	10 5	15
Fig 10	8.4.1.1	13	13
Fig 11	7.2.2.1 9.4.3.2	6 5	11
Fig 12	2.2.1.1	4	4
Fig 13	1.1.1.1 9.1.3.4	2 8	10
Total K = 165			

Sportmen 2015
 Pilot
 A/C



Italia 7 dicembre 2014		Form C
Pilot ID	CIVA	Flight #

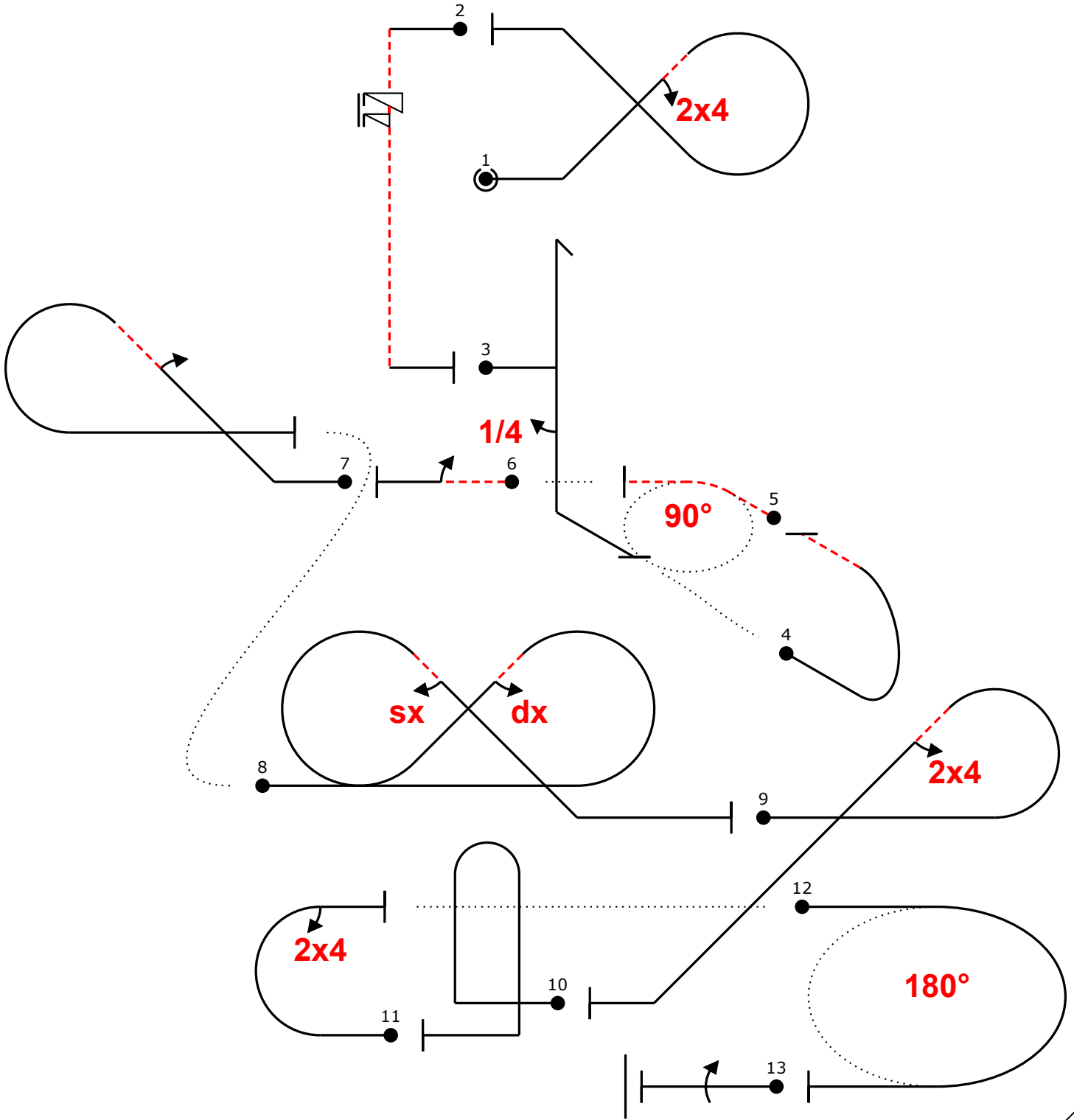
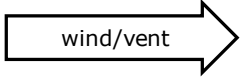

Sportmen 2015
 Pilot
 A/C